

Vortex Series

PP66V10

PERFORMANCE

Bare shaft, frame-mounted vortex pump end with Pioneer Prime vac-assist dry priming system

Size	6" x 6" (150 x 150 mm)
Flow, Max	1600 gpm 363 m ³ /hr 100 l/s
Head, Max	94 feet (29 meters)
Flow at BEP	850 gpm 193 m ³ /hr 54 l/s
Efficiency at BEP	45%
Solids Handling, Max	5.12" (130 mm)
Operating Speed, Max	2000 rpm
Suction Connection	6" (150 mm) 150 ANSI Flanges
Delivery Connection	6" (150 mm) 150 ANSI Flanges
Bearing Lubrication	Oil STD Grease optional
Fasteners	Imperial

APPLICATIONS

Waste Handling	Industrial Effluent
Sludges	Chemical Processing

PosiValve™ Patent #6,783,730



Vortex Series

Pioneer Pump® Vortex Series™ Pumps eliminate costly and disruptive downtime by passing through the most challenging solids using a recessed impeller, making them ideal for applications where fluid conditioning, macerating, or mix-prevention are unnecessary. Vortex technology saves time and money by eliminating internal wetted parts, like wear plates and chopper blades, that would otherwise have to be monitored, adjusted, and replaced.

FEATURES AND BENEFITS

Vortex Impeller	Recessed impeller passes challenging solids by avoiding direct contact
Discharge	Elbow ball valve style with cast iron body avoids clogs from passed-through solids
Check Valve	
Heavy Duty	Impeller and casing are cast in ductile iron and shaft is corrosion-resistant 17-4 for maximum reliability
Pioneer Prime System	Heavy-duty vacuum pump and priming chamber with PosiValve™ can start-up dry, re-prime faster, and will not leak pumpage onto the ground

SPECIFICATIONS

Mechanical Seal	Single type seal w/ tungsten carbide vs. silicon carbide seal faces, FKM elastomers, 300 series stainless steel hardware and spring (run dry option available)
Pump End Bearing	Single Row Ball
Drive End Bearing	Single Row Ball
O-rings	FKM
Shaft	17-4 PH Stainless Steel
SAE	SAE engine-mount bracket options available

MATERIALS OF CONSTRUCTION

Material	Standard Construction
Impeller	Ductile Iron 65-45-12
Shaft	17-4 PH Stainless Steel
Volute	Ductile Iron 65-45-12
Backplate	Ductile Iron 65-45-12

MECHANICAL DIMENSIONS

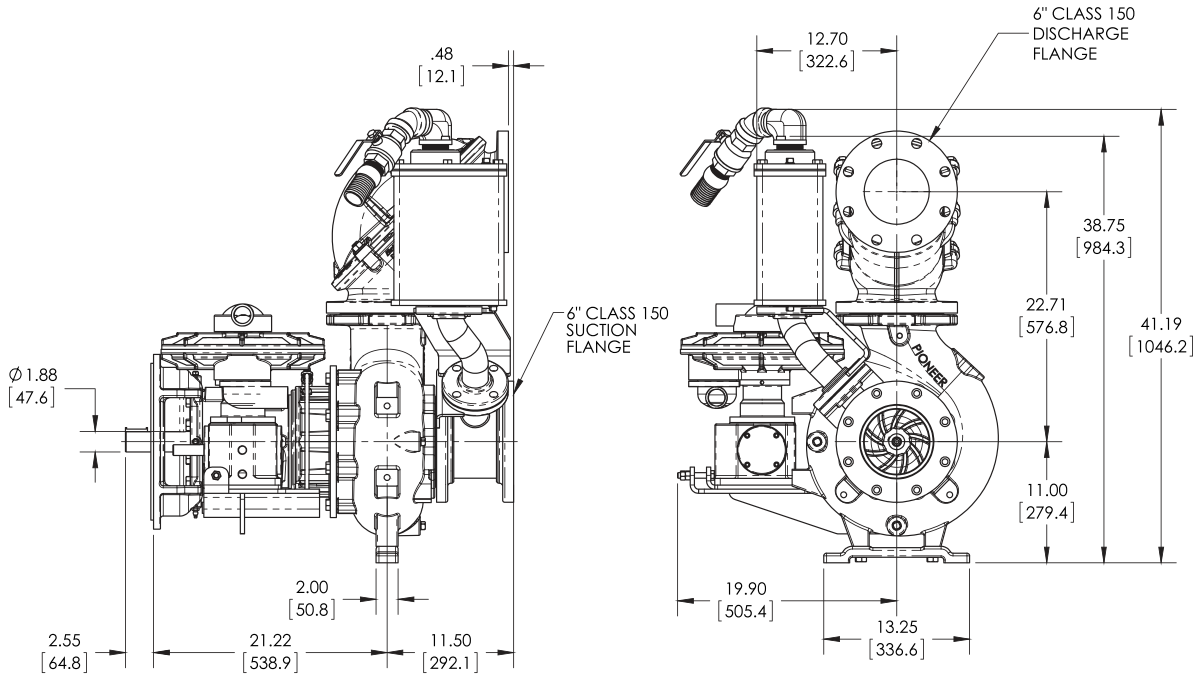

PERFORMANCE CURVE

Model: PP66V10

Impeller Dia: 9.65"

Speed: Variable

Curve #16277HQ

