





PES100

PORTABLE ENERGY STORAGE SYSTEM

SPECIFICATION



PES100 Portable Energy Storage System				
Item	Unit	Data		
Output power	kVA/kW	100/100		
Frequency	Hz	50		
Phase	P	3		
Power factor	PF	1		
Dimensions	mm	2600x2290x2525		
Dry weight	kg	3700		
40° Loading	Qty	4		
Protection class		IP54		
Noise level	dBA@7m	58		
Voltage	AC V	380	400	415
Current	A	152	144	139
Wiring port		L1、L2、L3、N、PE		
Voltage regulation range		±1%		
Load adaptation characteristics		Inductive load, resistive load		
Power connection input		AC socket: 3P/4W, 1x100kW DC socket: 1x30kW		
Power connection output		AC socket: 3P/4W, 1x100kW AC socket: 1P		
Certification standards		 UN 38.3 IEC 62619 IEC 62477  IEC 62933-2-1 CE Declaration of Conformity  VDE-AR-N 4110 EN-50549-1  UL 1973		

Classified Document
 2024.05

Intelligent Energy Management

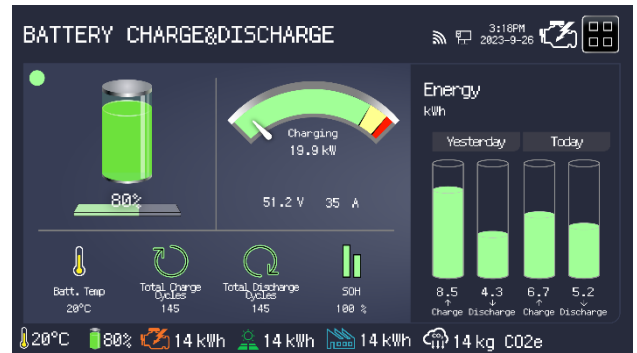
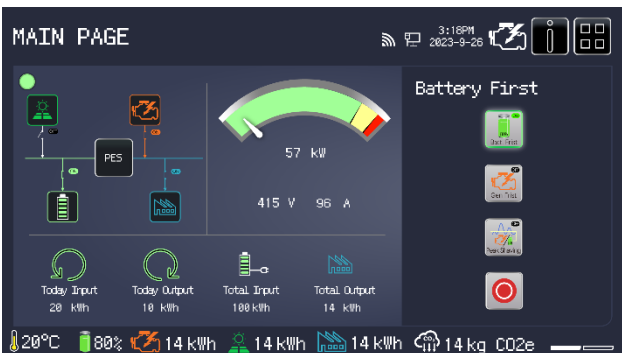

System Working Principle

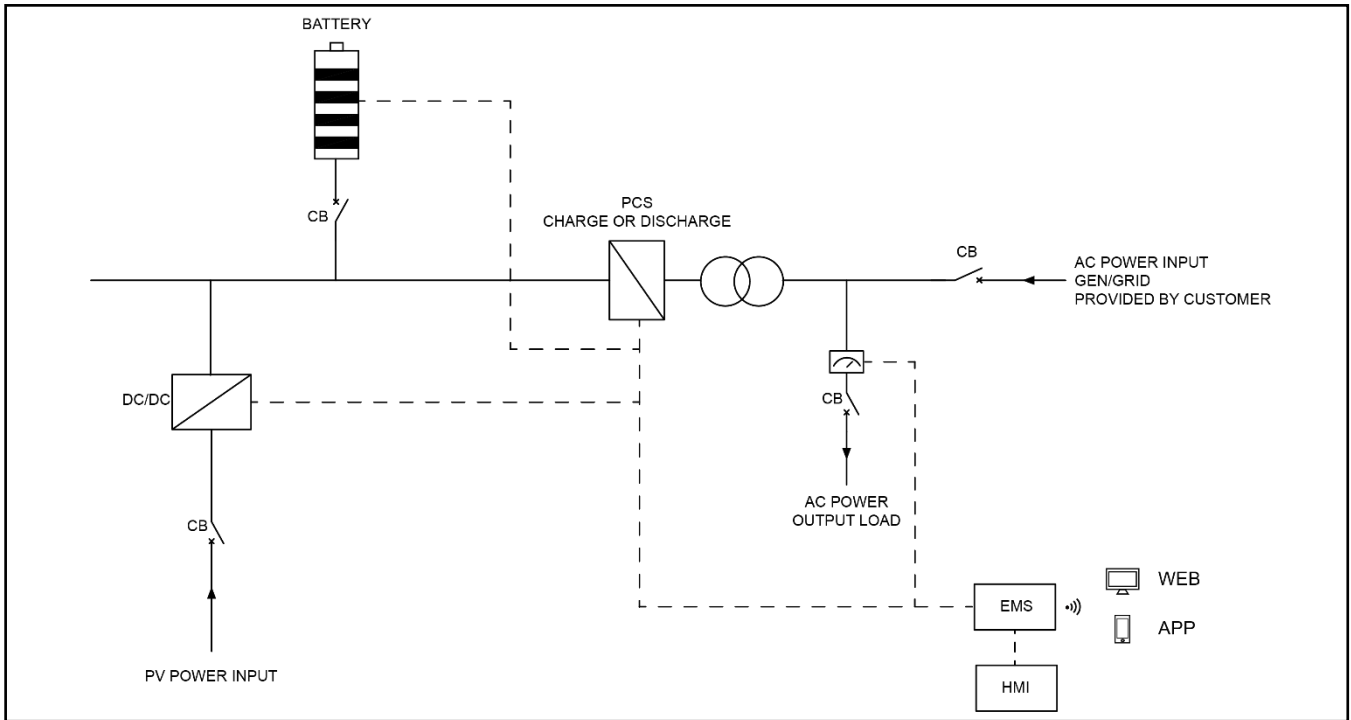

DC/AC System		
Rated power	kVA/kW	100/100
Output voltage	AC V	415/240
Overload capability		110% last 10mins, 115% last 1min

PV SYSTEM		
Rated power	kWp	30
Input voltage	DC V	0-650
NOTE: Solar panels are optional.		

Battery System		
Battery type		LiFePO4
Battery capacity	kWh	115
Rated voltage	DC V	768
Cooling system		Air-cooled
Max charging rate		1C
Max discharging rate		1C
Battery cycle life		>8000cycles(90%DOD, 1C)

CONTROL SYSTEM		
HMI control panel	inch	10.3" Touchscreen
Communication interface		WAN/WIFI/SIM
Cloud services		APP/WEB

* Data is subject to change without prior notice as new products are always developed. Please contact POWERLINK or local agent with any doubts or for more information.

Classified
Document
2024.05